DEWALT®

XR LI-ION

WWW.DEWALT.COM

DCG412

English (*original instructions*)

04

简体中文

22

Figure 1

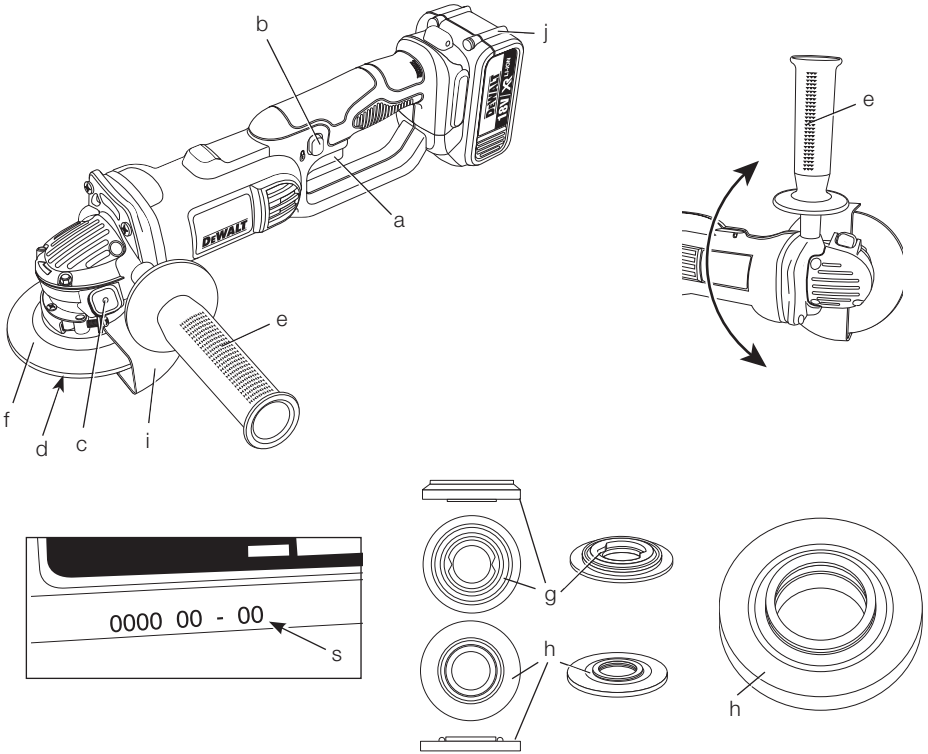

Figure 2

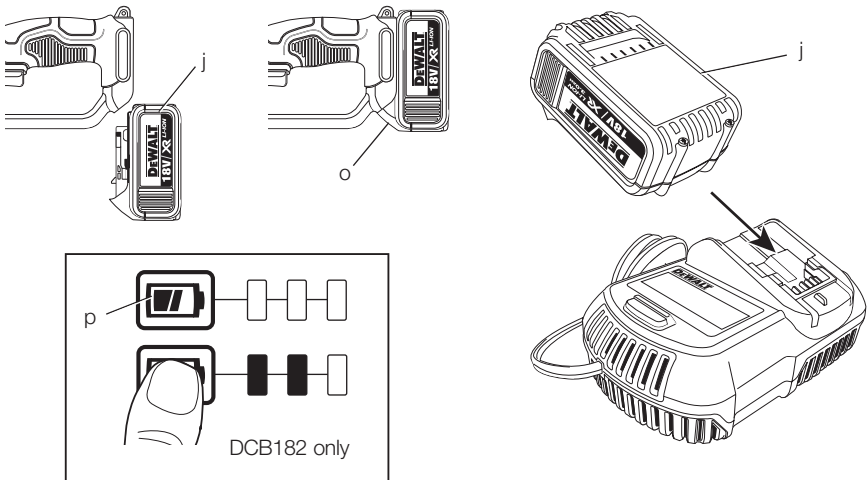

Figure 3

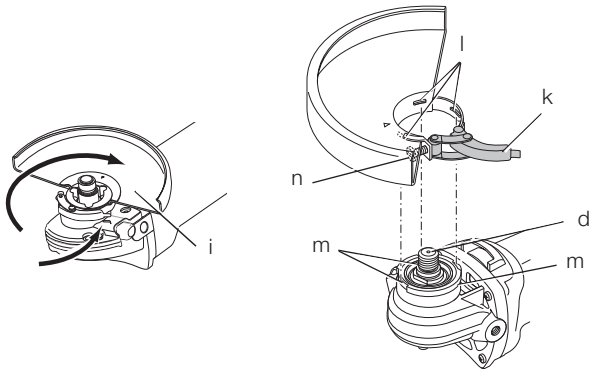

Figure 4

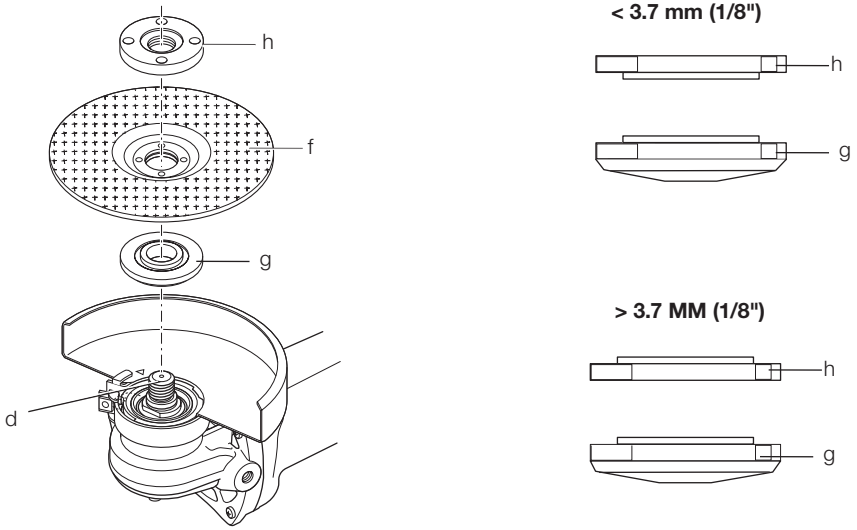

Figure 5

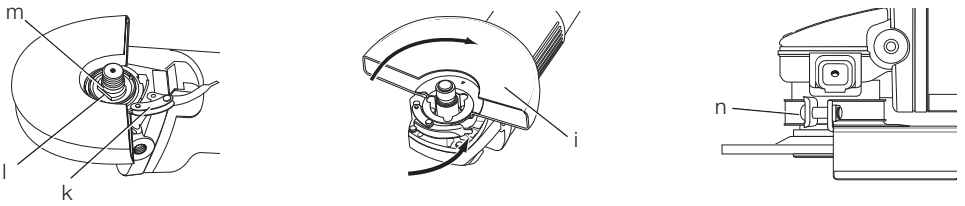

Figure 6

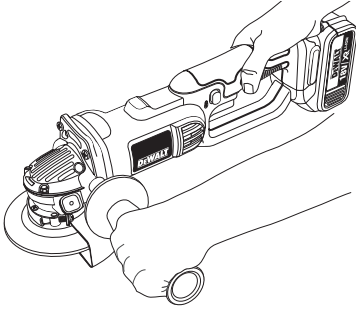
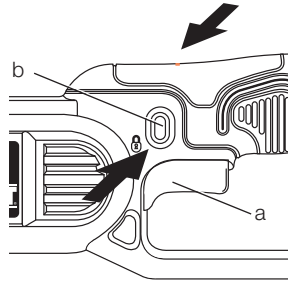

Figure 7



CORDLESS GRINDER

DCG412

Congratulations!

You have chosen a DEWALT tool. Years of experience, thorough product development and innovation make DEWALT one of the most reliable partners for professional power tool users.

Technical Data

		DCG412	
Voltage	V_{DC}	18	
Type		1	
Power input	W	405	
No-load/rated speed	min^{-1}	7000	
Wheel diameter	mm	100	
Spindle diameter		M10	
Weight (without battery pack)	kg	2.2*	

* weight includes side handle and guard

Battery pack	DCB180	DCB181	DCB182
Battery type	Li-Ion	Li-Ion	Li-Ion
Voltage	V_{DC}	18	18
Capacity	A_{h}	3.0	1.5
Weight	kg	0.64	0.35

Charger		DCB105	
Mains voltage	V_{AC}	220-240 V	
Battery type		Li-Ion	
Approx. charging time	min	30	55
		(1.5 Ah battery packs)	(3.0 Ah battery packs)
		70 (4.0 Ah battery packs)	
Weight	kg	0.49	

Definitions: Safety Guidelines

The definitions below describe the level of severity for each signal word. Please read the manual and pay attention to these symbols.



DANGER: Indicates an imminently hazardous situation which, if not avoided, **will result in death or serious injury.**



WARNING: Indicates a potentially hazardous situation which, if not avoided, **could result in death or serious injury.**



CAUTION: Indicates a potentially hazardous situation which, if not avoided, **may result in minor or moderate injury.**

NOTICE: Indicates a practice **not related to personal injury** which, if not avoided, **may result in property damage.**



Denotes risk of electric shock.



Denotes risk of fire.



WARNING: To reduce the risk of injury, read the instruction manual.

General Power Tool Safety Warnings



WARNING! Read all safety warnings and all instructions. Failure to follow the warnings and instructions may result in electric shock, fire and/or serious injury.

SAVE ALL WARNINGS AND INSTRUCTIONS FOR FUTURE REFERENCE

The term "power tool" in the warnings refers to your mains-operated (corded) power tool or battery-operated (cordless) power tool.

1) WORK AREA SAFETY

- Keep work area clean and well lit.**
Cluttered or dark areas invite accidents.
- Do not operate power tools in explosive atmospheres, such as in the presence of flammable liquids, gases or dust.** Power tools create sparks which may ignite the dust or fumes.
- Keep children and bystanders away while operating a power tool.** Distractions can cause you to lose control.

2) ELECTRICAL SAFETY

- Power tool plugs must match the outlet. Never modify the plug in any way. Do not use any adapter plugs with earthed (grounded) power tools.** Unmodified plugs and matching outlets will reduce risk of electric shock.
- Avoid body contact with earthed or grounded surfaces such as pipes, radiators, ranges and refrigerators.** There

is an increased risk of electric shock if your body is earthed or grounded.

- c) **Do not expose power tools to rain or wet conditions.** Water entering a power tool will increase the risk of electric shock.
- d) **Do not abuse the cord. Never use the cord for carrying, pulling or unplugging the power tool. Keep cord away from heat, oil, sharp edges or moving parts.** Damaged or entangled cords increase the risk of electric shock.
- e) **When operating a power tool outdoors, use an extension cord suitable for outdoor use.** Use of a cord suitable for outdoor use reduces the risk of electric shock.
- f) **If operating a power tool in a damp location is unavoidable, use a residual current device (RCD) protected supply.** Use of an RCD reduces the risk of electric shock.

3) PERSONAL SAFETY

- a) **Stay alert, watch what you are doing and use common sense when operating a power tool. Do not use a power tool while you are tired or under the influence of drugs, alcohol or medication.** A moment of inattention while operating power tools may result in serious personal injury.
- b) **Use personal protective equipment. Always wear eye protection.** Protective equipment such as dust mask, non-skid safety shoes, hard hat, or hearing protection used for appropriate conditions will reduce personal injuries.
- c) **Prevent unintentional starting. Ensure the switch is in the off position before connecting to power source and/or battery pack, picking up or carrying the tool.** Carrying power tools with your finger on the switch or energising power tools that have the switch on invites accidents.
- d) **Remove any adjusting key or wrench before turning the power tool on.** A wrench or a key left attached to a rotating part of the power tool may result in personal injury.
- e) **Do not overreach. Keep proper footing and balance at all times.** This enables better control of the power tool in unexpected situations.
- f) **Dress properly. Do not wear loose clothing or jewellery. Keep your hair, clothing and gloves away from moving parts.** Loose clothes, jewellery or long hair can be caught in moving parts.
- g) **If devices are provided for the connection of dust extraction and collection facilities,**

ensure these are connected and properly used. Use of dust collection can reduce dust-related hazards.

4) POWER TOOL USE AND CARE

- a) **Do not force the power tool. Use the correct power tool for your application.** The correct power tool will do the job better and safer at the rate for which it was designed.
- b) **Do not use the power tool if the switch does not turn it on and off.** Any power tool that cannot be controlled with the switch is dangerous and must be repaired.
- c) **Disconnect the plug from the power source and/or the battery pack from the power tool before making any adjustments, changing accessories, or storing power tools.** Such preventive safety measures reduce the risk of starting the power tool accidentally.
- d) **Store idle power tools out of the reach of children and do not allow persons unfamiliar with the power tool or these instructions to operate the power tool.** Power tools are dangerous in the hands of untrained users.
- e) **Maintain power tools. Check for misalignment or binding of moving parts, breakage of parts and any other condition that may affect the power tool's operation. If damaged, have the power tool repaired before use.** Many accidents are caused by poorly maintained power tools.
- f) **Keep cutting tools sharp and clean.** Properly maintained cutting tools with sharp cutting edges are less likely to bind and are easier to control.
- g) **Use the power tool, accessories and tool bits etc., in accordance with these instructions taking into account the working conditions and the work to be performed.** Use of the power tool for operations different from those intended could result in a hazardous situation.

5) BATTERY TOOL USE AND CARE

- a) **Recharge only with the charger specified by the manufacturer.** A charger that is suitable for one type of battery pack may create a risk of fire when used with another battery pack.
- b) **Use power tools only with specifically designated battery packs.** Use of any other battery packs may create a risk of injury and fire.

- c) **When battery pack is not in use, keep it away from other metal objects like paper clips, coins, keys, nails, screws or other small metal objects that can make a connection from one terminal to another.** Shorting the battery terminals together may cause burns or a fire.
- d) **Under abusive conditions, liquid may be ejected from the battery, avoid contact. If contact accidentally occurs, flush with water. If liquid contacts eyes, additionally seek medical help.** Liquid ejected from the battery may cause irritation or burns.
- 6) SERVICE**
- a) **Have your power tool serviced by a qualified repair person using only identical replacement parts.** This will ensure that the safety of the power tool is maintained.

ADDITIONAL SPECIFIC SAFETY RULES

Safety Instructions for All Operations

- a) **This power tool is intended to function as a grinder, wire brush or cut-off tool. Read all safety warnings, instructions, illustrations and specifications provided with this power tool.** Failure to follow all instructions listed below may result in electric shock, fire and/or serious injury.
- b) **Operations such as sanding and polishing are not recommended to be performed with this power tool.** Operations for which the power tool was not designed may create a hazard and cause personal injury.
- c) **Do not use accessories which are not specifically designed and recommended by the tool manufacturer.** Just because the accessory can be attached to your power tool, it does not assure safe operation.
- d) **The rated speed of the accessory must be at least equal to the maximum speed marked on the power tool.** Accessories running faster than their rated speed can break and fly apart.
- e) **The outside diameter and the thickness of your accessory must be within the capacity rating of your power tool.** Incorrectly sized accessories cannot be adequately guarded or controlled.
- f) **The arbour size of wheels, flanges, backing pads or any other accessory must properly fit the spindle of the power tool.** Accessories with arbour holes that do not match the mounting hardware of the power tool will run out of balance, vibrate excessively and may cause loss of control.
- g) **Do not use a damaged accessory. Before each use inspect the accessory such as abrasive wheel for chips and cracks, backing pad for cracks, tear or excess wear, wire brush for loose or cracked wires. If power tool or accessory is dropped, inspect for damage or install an undamaged accessory. After inspecting and installing an accessory, position yourself and bystanders away from the plane of the rotating accessory and run the power tool at maximum no-load speed for one minute.** Damaged accessories will normally break apart during this test time.
- h) **Wear personal protective equipment. Depending on application, use face shield, safety goggles or safety glasses. As appropriate, wear dust mask, hearing protectors, gloves and workshop apron capable of stopping small abrasive or workpiece fragments.** The eye protection must be capable of stopping flying debris generated by various operations. The dust mask or respirator must be capable of filtrating particles generated by your operation. Prolonged exposure to high intensity noise may cause hearing loss.
- i) **Keep bystanders a safe distance away from work area. Anyone entering the work area must wear personal protective equipment.** Fragments of workpiece or of a broken accessory may fly away and cause injury beyond immediate area of operation.
- j) **Hold power tool by insulated gripping surfaces only, when performing an operation where the cutting accessory may contact hidden wiring or its own cord.** Cutting accessory contacting a "live" wire may make exposed metal parts of the power tool "live" and shock the operator.
- k) **Position the cord clear of the spinning accessory.** If you lose control, the cord may be cut or snagged and your hand or arm may be pulled into the spinning accessory.
- l) **Never lay the power tool down until the accessory has come to a complete stop.** The spinning accessory may grab the surface and pull the power tool out of your control.
- m) **Do not run the power tool while carrying it at your side.** Accidental contact with the spinning accessory could snag your clothing, pulling the accessory into your body.

- n) **Regularly clean the power tool's air vents.**
The motor's fan will draw the dust inside the housing and excessive accumulation of powdered metal may cause electrical hazards.
- o) **Do not operate the power tool near flammable materials.** Sparks could ignite these materials.
- p) **Do not use accessories that require liquid coolants.** Using water or other liquid coolants may result in electrocution or shock.

FURTHER SAFETY INSTRUCTIONS FOR ALL OPERATIONS

Causes and Operator Prevention of Kickback

Kickback is a sudden reaction to a pinched or snagged rotating wheel, backing pad, brush or any other accessory. Pinching or snagging causes rapid stalling of the rotating accessory which in turn causes the uncontrolled power tool to be forced in the direction opposite of the accessory's rotation at the point of the binding.

For example, if an abrasive wheel is snagged or pinched by the workpiece, the edge of the wheel that is entering into the pinch point can dig into the surface of the material causing the wheel to climb out or kick out. The wheel may either jump toward or away from the operator, depending on direction of the wheel's movement at the point of pinching. Abrasive wheels may also break under these conditions.

Kickback is the result of power tool misuse and/or incorrect operating procedures or conditions and can be avoided by taking proper precautions as given **BELOW**:

- a) **Maintain a firm grip on the power tool and position your body and arm to allow you to resist kickback forces.** Always use auxiliary handle, if provided, for maximum control over kickback or torque reaction during start-up. The operator can control torque reaction or kickback forces, if proper precautions are taken.
- b) **Never place your hand near the rotating accessory.** Accessory may kickback over your hand.
- c) **Do not position your body in the area where power tool will move if kickback occurs.** Kickback will propel the tool in direction opposite to the wheel's movement at the point of snagging.
- d) **Use special care when working corners, sharp edges etc. Avoid bouncing and**

snagging the accessory. Corners, sharp edges or bouncing have a tendency to snag the rotating accessory and cause loss of control or kickback.

- e) **Do not attach a saw chain woodcarving blade or toothed saw blade.** Such blades create frequent kickback and loss of control.

Safety Warnings Specific for Grinding and Abrasive Cutting-Off Operations

- a) **Use only wheel types that are recommended for your power tool and the specific guard designed for the selected wheel.** Wheels for which the power tool was not designed cannot be adequately guarded and are unsafe.
- b) **The guard must be securely attached to the power tool and positioned for maximum safety, so the least amount of wheel is exposed towards the operator.** The guard helps to protect operator from broken wheel fragments and accidental contact with wheel and sparks that could ignite clothing.
- c) **Wheels must be used only for recommended applications. For example: do not grind with the side of cut-off wheel.** Abrasive cut-off wheels are intended for peripheral grinding, side forces applied to these wheels may cause them to shatter.
- d) **Always use undamaged wheel flanges that are of correct size and shape for your selected wheel.** Proper wheel flanges support the wheel thus reducing the possibility of wheel breakage. Flanges for cut-off wheels may be different from grinding wheel flanges.
- e) **Do not use worn down wheels from larger power tools.** Wheel intended for larger power tool is not suitable for the higher speed of a smaller tool and may burst.

Additional Safety Warnings Specific for Abrasive Cutting-Off Operations

- a) **Do not "jam" the cut-off wheel or apply excessive pressure. Do not attempt to make an excessive depth of cut.** Overstressing the wheel increases the loading and susceptibility to twisting or binding of the wheel in the cut and the possibility of kickback or wheel breakage.
- b) **Do not position your body in line with and behind the rotating wheel.** When the wheel, at the point of operations, is moving away from your body, the possible kickback may propel the spinning wheel and the power tool directly at you.

- c) *When wheel is binding or when interrupting a cut for any reason, switch off the power tool and hold the power tool motionless until the wheel comes to a complete stop. Never attempt to remove the cut-off wheel from the cut while the wheel is in motion otherwise kickback may occur. Investigate and take corrective action to eliminate the cause of wheel binding.*
 - d) *Do not restart the cutting operation in the workpiece. Let the wheel reach full speed and carefully reenter the cut. The wheel may bind, walk up or kickback if the power tool is restarted in the workpiece.*
 - e) *Support panels or any oversized workpiece to minimise the risk of wheel pinching and kickback. Large workpieces tend to sag under their own weight. Supports must be placed under the workpiece near the line of cut and near the edge of the workpiece on both sides of the wheel.*
 - f) *Use extra caution when making a “pocket cut” into existing walls or other blind areas. The protruding wheel may cut gas or water pipes, electrical wiring or objects that can cause kickback.*
- **Do not use Type 11 (flaring cup) wheels on this tool.** *Using inappropriate accessories can result in injury.*
 - **Always use side handle. Tighten the handle securely.** *The side handle should always be used to maintain control of the tool at all times.*

Residual Risks

In spite of the application of the relevant safety regulations and the implementation of safety devices, certain residual risks cannot be avoided. These are:

- Impairment of hearing.
- Risk of personal injury due to flying particles.
- Risk of burns due to accessories becoming hot during operation.
- Risk of personal injury due to prolonged use.
- Risk of dust from hazardous substances.

Markings on Tool

The following pictograms are shown on the tool:



Read instruction manual before use.



Wear ear protection.



Wear eye protection.

Safety Warnings Specific for Wire Brushing Operations

- a) *Be aware that wire bristles are thrown by the brush even during ordinary operation. Do not overstress the wires by applying excessive load to the brush. The wire bristles can easily penetrate light clothing and/or skin.*
- b) *If the use of a guard is recommended for wire brushing, do not allow any interference of the wire wheel or brush with the guard. Wire wheel or brush may expand in diameter due to work and centrifugal forces.*

Additional Safety Information

- *Threaded mounting of accessories must match the grinder spindle thread. For accessories mounted by flanges, the arbor hole of the accessory must fit the locating diameter of the flange. Accessories that do not match the mounting hardware of the power tool will run out of balance, vibrate excessively and may cause loss of control.*
- *The grinding surface of the centre depressed wheels must be mounted below the plane of the guard lip. An improperly mounted wheel that projects through the plane of the guard lip cannot be adequately protected.*

DATE CODE POSITION (FIG. 1)

The date code (s), which also includes the year of manufacture, is printed into the housing.

Example:

2012 XX XX

Year of Manufacture

Important Safety Instructions for All Battery Chargers

SAVE THESE INSTRUCTIONS: *This manual contains important safety and operating instructions for the DCB105 battery charger.*

- *Before using the charger, read all instructions and cautionary markings on charger, battery pack and product using the battery pack.*



WARNING: *Shock hazard. Do not allow any liquid to get inside charger. Electric shock may result.*



CAUTION: Burn hazard. To reduce the risk of injury, charge only DEWALT rechargeable battery packs. Other types of batteries may overheat and burst resulting in personal injury and property damage.



CAUTION: Children should be supervised to ensure that they do not play with the appliance.

NOTICE: Under certain conditions, with the charger plugged in to the power supply, the exposed charging contacts inside the charger can be shorted by foreign material. Foreign materials of a conductive nature such as, but not limited to, steel wool, aluminum foil or any buildup of metallic particles should be kept away from charger cavities. Always unplug the charger from the power supply when there is no battery pack in the cavity. Unplug charger before attempting to clean.

- **DO NOT attempt to charge the battery pack with any chargers other than the ones in this manual.** The charger and battery pack are specifically designed to work together.
- **These chargers are not intended for any uses other than charging DEWALT rechargeable batteries.** Any other uses may result in risk of fire, electric shock or electrocution.
- **Do not expose charger to rain or snow.**
- **Pull by plug rather than cord when disconnecting charger.** This will reduce risk of damage to electric plug and cord.
- **Make sure that cord is located so that it will not be stepped on, tripped over or otherwise subjected to damage or stress.**
- **Do not use an extension cord unless it is absolutely necessary.** Use of improper extension cord could result in risk of fire, electric shock or electrocution.
- **When operating a charger outdoors, always provide a dry location and use an extension cord suitable for outdoor use.** Use of a cord suitable for outdoor use reduces the risk of electric shock.
- **Do not block the ventilation slots on the charger.** The ventilation slots are located on the top and sides of the charger. Place the charger in a position away from any heat source.
- **Do not operate charger with damaged cord or plug — have them replaced immediately.**

- **Do not operate charger if it has received a sharp blow, been dropped or otherwise damaged in any way.** Take it to an authorised service centre.
- **Do not disassemble the charger; take it to an authorised service centre when service or repair is required.** Incorrect reassembly may result in a risk of electric shock, electrocution or fire.
- **In case of damaged power supply cord the supply cord must be replaced immediately by the manufacturer, its service agent or similar qualified person to prevent any hazard.**
- **Disconnect the charger from the outlet before attempting any cleaning.** This will reduce the risk of electric shock. Removing the battery pack will not reduce this risk.
- **NEVER attempt to connect 2 chargers together.**
- **The charger is designed to operate on standard 220-240 V household electrical power. Do not attempt to use it on any other voltage.** This does not apply to the vehicular charger.

SAVE THESE INSTRUCTIONS

Chargers

The DCB105 charger accepts 10.8 V, 14.4 V and 18 V Li-Ion (DCB121, DCB123, DCB140, DCB141, DCB142, DCB180, DCB181 and DCB182) battery packs.

This charger requires no adjustment and is designed to be as easy as possible to operate.





Charging Procedure (fig. 2)

1. Plug the charger into an appropriate 220-240 V outlet before inserting the battery pack.
2. Insert the battery pack (j) into the charger, making sure the pack is fully seated in the charger. The red (charging) light will blink continuously indicating that the charging process has started.
3. The completion of charge will be indicated by the red light remaining ON continuously. The pack is fully charged and may be used at this time or left in the charger.

NOTE: To ensure maximum performance and life of Li-Ion batteries, charge the battery pack fully before first use.

Charging Process

Refer to the table below for the state of charge of the battery pack.

State of charge	
 charging	— — — —
 fully charged	—————
 hot/cold pack delay	— • — • — • — •
 problem pack or charger	• • • • • • • • • •
 problem powerline	• • • • • • • •

This charger will not charge a faulty battery pack. The charger will indicate faulty battery by refusing to light or by displaying problem pack or charger blink pattern.

NOTE: This could also mean a problem with a charger.

If the charger indicates a problem, take the charger and battery pack to be tested at an authorised service centre.

Hot/Cold Pack Delay

When the charger detects a battery that is too hot or too cold, it automatically starts a hot/cold pack delay, suspending charging until the battery has reached an appropriate temperature. The charger then automatically switches to the pack charging mode. This feature ensures maximum battery life.

XR Li-Ion tools are designed with an Electronic Protection System that will protect the battery against overloading, overheating or deep discharge.

The tool will automatically turn off if the Electronic Protection System engages. If this occurs, place the Li-Ion battery on the charger until it is fully charged.

A cold battery pack will charge at about half the rate of a warm battery pack. The battery pack will charge at that slower rate throughout the entire charging cycle and will not return to maximum charge rate even if the battery warms.

Important Safety Instructions for All Battery Packs

When ordering replacement battery packs, be sure to include the catalog number and voltage.

The battery pack is not fully charged out of the carton. Before using the battery pack and charger, read the safety instructions below and then follow the charging procedures outlined.

READ ALL INSTRUCTIONS

- **Do not charge or use the battery pack in explosive atmospheres, such as in the presence of flammable liquids, gases or dust.** Inserting or removing the battery pack from the charger may ignite the dust or fumes.

- **Never force the battery pack into charger. Do not modify the battery pack in any way to fit into a non-compatible charger as battery pack may rupture causing serious personal injury.**
- Charge the battery packs only in designated DEWALT chargers.
- **DO NOT splash or immerse in water or other liquids.**
- **Do not store or use the tool and battery pack in locations where the temperature may reach or exceed 40 °C (105 °F) (such as outside sheds or metal buildings in summer).**
- For best results, make sure the battery pack is fully charged before use.



WARNING: Never attempt to open the battery pack for any reason. If the battery pack case is cracked or damaged, do not insert it into the charger. Do not crush, drop or damage battery pack. Do not use a battery pack or charger that has received a sharp blow, been dropped, run over or damaged in any way (e.g., pierced with a nail, hit with a hammer, stepped on). Electric shock or electrocution may result. Damaged battery packs should be returned to the service centre for recycling.



CAUTION: When not in use, place tool on its side on a stable surface where it will not cause a tripping or falling hazard. Some tools with large battery packs will stand upright on the battery pack but may be easily knocked over.

SPECIFIC SAFETY INSTRUCTIONS FOR LITHIUM ION (Li-Ion)

- **Do not incinerate the battery pack even if it is severely damaged or is completely worn out.** The battery pack can explode in a fire. Toxic fumes and materials are created when lithium ion battery packs are burned.
- **If battery contents come into contact with the skin, immediately wash the area with mild soap and water.** If the battery liquid gets into the eye, rinse water over the open eye for 15 minutes or until irritation ceases. If medical attention is needed, the battery electrolyte is composed of a mixture of liquid organic carbonates and lithium salts.
- **Contents of opened battery cells may cause respiratory irritation.** Provide fresh air. If symptoms persists, seek medical attention.



WARNING: Burn hazard. Battery liquid may be flammable if exposed to spark or flame.

Battery Pack

BATTERY TYPE

The DCG412 operates on 18 volt battery pack.

The DCB180, DCB181 or DCB182 battery packs may be used. Refer to **Technical Data** for more information.

Storage Recommendations

1. The best storage place is one that is cool and dry away from direct sunlight and excess heat or cold. For optimum battery performance and life, store battery packs at room temperature when not in use.
2. For long storage, it is recommended to store a fully charged battery pack in a cool, dry place out of the charger for optimal results.

NOTE: Battery packs should not be stored completely depleted of charge. The battery pack will need to be recharged before use.

Labels on Charger and Battery Pack

In addition to the pictographs used in this manual, the labels on the charger and the battery pack show the following pictographs:



Read instruction manual before use.



Charging.



Fully charged.



Hot/cold pack delay.



Problem pack or charger.



Problem powerline.



Do not probe with conductive objects.



Do not charge damaged battery packs.



Use only with DEWALT battery packs. Others may burst, causing personal injury and damage.



Do not expose to water.



Have defective cords replaced immediately.



Charge only between 4° C and 40° C.



LI-ION

Discard the battery pack with due care for the environment.



Do not incinerate the battery pack.



Charges Li-Ion battery packs.



See **Technical data** for charging time.



Only for indoor use.

Package Contents

The package contains:

- 1 Angle grinder
- 1 125 mm Guard (Type 27)
- 1 Side handle
- 1 Flange set
- 1 Two-pin spanner
- 1 Charger
- 2 Li-Ion battery packs (M2, L2 models)
- 1 Instruction manual

NOTE: Battery packs, chargers and kitboxes are not included with N-models.

- Check for damage to the tool, parts or accessories which may have occurred during transport.
- Take the time to thoroughly read and understand this manual prior to operation.

Description (fig. 1–6)



WARNING: Never modify the power tool or any part of it. Damage or personal injury could result.

- a. Trigger switch
- b. Lock-off button
- c. Spindle lock button

- d. Spindle
- e. Side handle
- f. Abrasive wheel
- g. Backing flange
- h. Threaded clamp nut
 - i. Guard
 - j. Battery pack
 - k. Guard catch
 - l. Lugs
- m. Gear case slots
- n. Adjusting screw
- o. Battery release button
- p. fuel gauge button (DCB182 only)

INTENDED USE

The DCG412 heavy-duty angle grinder has been designed for professional grinding and cutting applications.

DO NOT use grinding wheels other than centre depressed wheels and flap discs.

DO NOT use under wet conditions or in the presence of flammable liquids or gases.

This heavy-duty angle grinder is a professional power tools.

DO NOT let children come into contact with the tool. Supervision is required when inexperienced operators use this tool.

- This product is not intended for use by persons (including children) suffering from diminished physical, sensory or mental abilities; lack of experience, knowledge or skills unless they are supervised by a person responsible for their safety. Children should never be left alone with this product.

Electrical Safety

The electric motor has been designed for one voltage only. Always check that the battery pack voltage corresponds to the voltage on the rating plate. Also make sure that the voltage of your charger corresponds to that of your mains.



Your DEWALT charger is double insulated in accordance with EN 60335; therefore no earth wire is required.

If the supply cord is damaged, it must be replaced by a specially prepared cord available through the DEWALT service organisation.

Using an Extension Cable

An extension cord should not be used unless absolutely necessary. Use an approved extension cable suitable for the power input of your charger (see **Technical Data**). The minimum conductor size is 1 mm²; the maximum length is 30 m.

When using a cable reel, always unwind the cable completely.

ASSEMBLY AND ADJUSTMENTS



WARNING: To reduce the risk of serious personal injury, turn tool off and disconnect tool from power source before making any adjustments or removing/installing attachments or accessories. Before reconnecting the tool, depress and release the trigger switch to ensure that the tool is off.



WARNING: Use only DEWALT battery packs and chargers.

Inserting and Removing the Battery Pack from the Tool (fig. 2)

NOTE: For best results, make sure your battery pack is fully charged.

TO INSTALL THE BATTERY PACK INTO THE TOOL HANDLE

1. Align the battery pack (j) with the rails inside the tool's handle (fig. 2).
2. Slide it into the handle until the battery pack is firmly seated in the tool and ensure that it does not disengage.

TO REMOVE THE BATTERY PACK FROM THE TOOL

1. Press the battery release button (o) and firmly pull the battery pack out of the tool handle.
2. Insert battery pack into the charger as described in the charger section of this manual.

FUEL GAUGE BATTERY PACKS (FIG. 2)

Some DEWALT battery packs include a fuel gauge which consists of three green LED lights that indicate the level of charge remaining in the battery pack.

To actuate the fuel gauge, press and hold the fuel gauge button (p). A combination of the three green LED lights will illuminate designating the level of charge left. When the level of charge in the battery is below the usable limit, the fuel gauge will not illuminate and the battery will need to be recharged.

NOTE: The fuel gauge is only an indication of the charge left on the battery pack. It does not indicate tool functionality and is subject to variation based on product components, temperature and end-user application.

Attaching Side Handle (fig. 1)



WARNING: Before using the tool, check that the handle is tightened securely.



WARNING: The side handle should always be used to maintain control of the tool at all times.

Screw the side handle (e) tightly into one of the holes on either side of the gear case.

To improve user comfort, the gear case will rotate 90° for cutting operations.

Rotating the Gear Case (fig. 1)

1. Remove the four corner screws attaching the gear case to motor housing.
2. Without separating the gear case from motor housing, rotate the gear case head to desired position.

NOTE: If the gear case and motor housing become separated by more than 1/8" (3.17 mm), the tool must be serviced and re-assembled by an authorised DEWALT service center. Failure to have the tool serviced may cause brush, motor and bearing failure.

3. Reinstall screws to attach the gear case to the motor housing. Tighten screws to 20 in.-lbs. torque. Overtightening could cause screws to strip.

Mounting and Removing the Guard (fig. 3)



WARNING: To reduce the risk of serious personal injury, turn tool off and disconnect tool from power source before making any adjustments or removing/installing attachments or accessories. Before reconnecting the tool, depress and release the trigger switch to ensure that the tool is off.



CAUTION: Guards must be used with this grinder.

When using the DCG412 grinder for cutting metal or masonry a Type 1 guard **MUST** be used. Type 1 guards are available at extra cost from DEWALT distributors.

NOTE: Please refer to the **Grinding and Cutting Accessory Chart** at the end of this section to see other accessories that can be used with these grinders.

1. Place the tool on a table, spindle (d) up.
2. Open the guard latch (k), and align the lugs (l) on the guard with the slots on the gear case (m).
3. Push the guard down until the guard lugs engage and rotate freely in the groove on the gear case hub.
4. With the guard latch open, rotate the guard (i) into the desired working position.
5. Close the guard latch to secure the guard on the gear case.



CAUTION: If the guard cannot be tightened by the adjusting screw (n), do not use the tool. To reduce the risk of personal injury, take the tool and guard to a service center to repair or replace the guard.

NOTICE: Do not tighten the adjusting screw (n) with the clamp lever in the open position. Undetectable damage to the guard or the mounting hub may result.

NOTE: Edge grinding and cutting can be performed with Type 27 wheels designed and specified for this purpose; 6.35 mm (1/4") thick wheels are designed for surface grinding while 3.17 mm (1/8") wheels are designed for edge grinding.

Mounting Depressed Center Grinding Wheels

NOTE: The Type 27 guard supplied with grinder **MUST** be used.

MOUNTING AND REMOVING HUBBED WHEELS (FIG. 1, 4)

Hubbed wheels install directly on the M10 threaded spindle.

1. Thread the wheel on the spindle (d) by hand.
2. Depress the spindle lock button (c) and use a wrench to tighten the hub of the wheel.
3. Reverse the above procedure to remove the wheel.

NOTICE: Failure to properly seat the wheel before turning the tool on may result in damage to the tool or the wheel.

MOUNTING NON-HUBBED WHEELS (FIG. 1, 4)

NOTE: The Type 27 guard supplied with grinder **MUST** be used.

NOTE: Please refer to the **Grinding and Cutting Accessory Chart** at the end of this section to see other accessories that can be used with these grinders.

1. Place the tool on a table, guard up.
2. Install the unthreaded backing flange (g) on spindle (d) with the raised centre against the wheel.
3. Place wheel (f) against the backing flange, centering the wheel on the raised centre of the backing flange.
4. While depressing the spindle lock button (c), thread the clamp nut (h) on spindle. If the wheel you are installing is more than 1/8" (3.17mm) thick, place the threaded clamp nut on the spindle so that the raised centre fits into the center of the wheel. If the wheel you are installing is 1/8" (3.17 mm) thick or less, place the threaded clamp nut on the spindle so that the raised centre is not against the wheel.
5. While depressing the spindle lock button (c), tighten the clamp nut with a wrench.
6. To remove the wheel, depress the spindle lock button and loosen the threaded clamp nut with a wrench.

NOTE: If the wheel spins after the clamp nut is tightened, check the orientation of the threaded clamp nut. If a thin wheel is installed with the raised centre on the clamp nut against the wheel, it will spin because the height of the raised centre prevents the clamp nut from holding the wheel.

Mounting Wire Brushes and Wire Wheels (fig. 1)

Wire cup brushes or wire wheels install directly on the threaded spindle without the use of flanges. Use only wire brushes or wheels provided with a M10 threaded hub. These accessories are available at extra cost from your local dealer or authorised service center.

NOTE: The Type 27 guard is required when using wire brushes and wheels.



CAUTION: To reduce the risk of personal injury, wear work gloves when handling wire brushes and wheels. They can become sharp.



CAUTION: To reduce the risk of damage to the tool, wheel

or brush must not touch guard when mounted or while in use. Undetectable damage could occur to the accessory, causing wires to fragment from accessory wheel or cup.

MOUNTING WIRE CUP BRUSHES AND WIRE WHEELS

1. Place the tool on a table, guard up.
2. Thread the wheel on the spindle by hand.
3. Depress spindle lock button (c) and use a wrench on the hub of the wire wheel or brush to tighten the wheel.
4. To remove the wheel, reverse the above procedure.

NOTE: To reduce the risk of damage to the tool, properly seat the wheel hub before turning the tool on.

Mounting Cutting (Type 1) Wheels

Cutting wheels include diamond wheels and abrasive discs. Abrasive cutting wheels for metal and concrete use are available. Diamond blades for concrete cutting can also be used. These accessories are available at extra cost from your local dealer or authorised service center.



WARNING: A closed, two-sided cutting wheel guard is required when using cutting wheels. These accessories are available at extra cost from your local dealer or authorised service center. Failure to use proper flange and guard can result in injury resulting from wheel breakage and wheel contact. Please refer to the **Grinding and Cutting Accessory Chart** at the end of this section to see other accessories that can be used with these grinders.



WARNING: To reduce the risk of serious personal injury, turn tool off and disconnect tool from power source before making any adjustments or removing/installing attachments or accessories. Before reconnecting the tool, depress and release the trigger switch to ensure that the tool is off.

MOUNTING CLOSED (TYPE 1) GUARD (FIG. 5)

1. Open the guard latch (k), and align the lugs (l) on the guard with the slots on the gear case (m). This will align the lugs with slots on the gear case cover. Position the guard facing backward.
2. Push the guard down until the guard lug engages and rotates freely in the groove on the gear case hub.

3. Rotate guard (f) into desired working position. The guard body should be positioned between the spindle and the operator to provide maximum operator protection.
4. Close the guard latch to secure the guard on the gear case cover. You should be unable to rotate the guard by hand when the latch is in closed position. Do not operate grinder with a loose guard or clamp lever in open position.
5. To remove the guard, open the guard latch, rotate the guard so that the arrows are aligned and pull up on the guard.

NOTE: The guard is pre-adjusted to the diameter of the gear case hub at the factory. If, after a period of time, the guard becomes loose, tighten the adjusting screw (n) with the clamp lever in the closed position with guard installed on the tool.

NOTICE: To reduce the risk of damage to the tool, do not tighten adjusting screw (n) with clamp lever in open position. Undetectable damage to guard or mounting hub may result.

MOUNTING CUTTING WHEELS (FIG. 1, 4)



CAUTION: Matching diameter backing flange and clamp nut (included with tool) must be used for cutting wheels.

1. Place the unthreaded backing flange on spindle with the raised centre facing up. The raised centre on the backing flange will be against the wheel when the wheel is installed.
2. Place the wheel on the backing flange, centering the wheel on the raised centre.
3. Install the threaded clamp nut with the raised centre away from the wheel.
4. Depress the spindle lock button (c) and tighten clamp nut with a wrench.
5. To remove the wheel, depress the spindle lock button and loosen the threaded clamp nut with a wrench.

Prior to Operation

- Install the guard and appropriate disc or wheel. Do not use excessively worn discs or wheels.
- Be sure the inner and outer flanges are mounted correctly.
- Make sure the disc or wheel rotates in the direction of the arrows on the accessory and the tool.

OPERATION

Instructions for Use



WARNING: Always observe the safety instructions and applicable regulations.



WARNING: To reduce the risk of serious personal injury, turn tool off and disconnect tool from power source before making any adjustments or removing/installing attachments or accessories. Before reconnecting the tool, depress and release the trigger switch to ensure that the tool is off.



WARNING:

- Ensure all materials to be ground or cut are secured in place.
- Use clamps or a vice to hold and support the workpiece to a stable platform. It is important to clamp and support the workpiece securely to prevent the movement of the workpiece and loss of control. Movement of the workpiece or loss of control may create a hazard and cause personal injury.
- Apply only a gentle pressure to the tool. Do not exert side pressure on the disc.
- Always wear regular working gloves while operating this tool.
- The gear case becomes very hot during use.
- Always install the guard and appropriate disc or wheel. Do not use excessively worn disc or wheel.
- Be sure the inner and outer flange are mounted correctly.
- Make sure the disc or wheel rotates in the direction of the arrows on the accessory and the tool.
- Avoid overloading. Should the tool become hot, let it run a few minutes under no-load condition.

Proper Hand Position (fig. 1, 6)



WARNING: To reduce the risk of serious personal injury, **ALWAYS** use proper hand position as shown.



WARNING: To reduce the risk of serious personal injury, **ALWAYS** hold securely in anticipation of a sudden reaction.

Proper hand position requires one hand on the side handle (e), with the other hand on the body of the tool, as shown in figure 6.

Switch



WARNING: Before using the tool, check that the handle is tightened securely.

LOCK-OFF BUTTON AND TRIGGER SWITCH (FIG. 7)

Your cut-off tool is equipped with a lock-off button (b).

To lock the trigger switch (a), press the lock-off button as shown in figure 7. When the lock-off button is depressed to the lock icon, the unit is locked.

Always lock the trigger switch when carrying or storing the tool to eliminate unintentional starting.

To unlock the trigger switch, press the lock-off button (b). When the lock-off button is depressed to the unlock icon, the unit is unlocked. The lock-off button is colored **red** to indicate when the switch is in its **unlocked** position.

Pull the trigger switch (a) to turn the motor ON. Releasing the trigger switch turns the motor OFF.

NOTE: This tool has no provision to lock the switch in the ON position, and should never be locked ON by any other means.



WARNING: Hold the side handle and body of the tool firmly to maintain control of the tool at start up and during use and until the wheel or accessory stops rotating. Make sure the wheel has come to a complete stop before laying the tool down.



WARNING: Allow the tool to reach full speed before touching tool to the work surface. Lift the tool from the work surface before turning the tool off.

Spindle Lock (fig. 1)

The spindle lock (c) is provided to prevent the spindle from rotating when installing or removing wheels. Operate the spindle lock only when the tool is turned off, unplugged from the power supply, and has come to a complete stop.

NOTICE: To reduce the risk of damage to the tool, do not engage the spindle lock while the tool is operating. Damage to the tool will result and attached accessory may spin off possibly resulting in injury.

To engage the lock, depress the spindle lock button (c) and rotate the spindle until you are unable to rotate the spindle further.

Using Depressed Center Grinding Wheels

SURFACE GRINDING WITH GRINDING WHEELS

1. Allow the tool to reach full speed before touching the tool to the work surface.
2. Apply minimum pressure to the work surface, allowing the tool to operate at high speed. Grinding rate is greatest when the tool operates at high speed.
3. Maintain a 20° to 30° angle between the tool and work surface.
4. Continuously move the tool in a forward and back motion to avoid creating gouges in the work surface.
5. Remove the tool from work surface before turning tool off. Allow the tool to stop rotating before laying it down.

EDGE GRINDING WITH GRINDING WHEELS



WARNING: Wheels used for cutting and edge grinding may break or kickback if they bend or twist while the tool is being used to do cut-off work or deep grinding. To reduce the risk of serious injury, limit the use of these wheels with a standard Type 27 guard to shallow cutting and notching (less than 1/2" [13 mm] in depth). The open side of the guard must be positioned away from the operator. For deeper cutting with a Type 1 cut-off wheel, use a closed Type 1 guard. Please refer to the **Grinding and Cutting Accessory Chart** at the end of this section to see other accessories that can be used with these grinders.

1. Allow the tool to reach full speed before touching the tool to the work surface.
2. Apply minimum pressure to the work surface, allowing the tool to operate at high speed. Grinding rate is greatest when the tool operates at high speed.
3. Position yourself so that the open-underside of the wheel is facing away from you.
4. Once a cut is begun and a notch is established in the workpiece, do not change the angle of the cut. Changing the angle will cause the wheel to bend and may cause wheel breakage. Edge grinding wheels are not designed to withstand side pressures caused by bending.

- Remove the tool from the work surface before turning the tool off. Allow the tool to stop rotating before laying it down.



WARNING: Do not use edge grinding/cutting wheels for surface grinding applications because these wheels are not designed for side pressures encountered with surface grinding. Wheel breakage and serious personal injury may result.

Mounting and Using Wire Brushes and Wire Wheels

Wire wheels and brushes can be used for removing rust, scale and paint, and for smoothing irregular surfaces.

NOTE: Please refer to **Precautions To Take When Wire Brushing Paint**.

- Allow the tool to reach full speed before touching the tool to the work surface.
- Apply minimum pressure to work surface, allowing the tool to operate at high speed. Material removal rate is greatest when the tool operates at high speed.
- Maintain a 5° to 10° angle between the tool and work surface for wire cup brushes.
- Maintain contact between the edge of the wheel and the work surface with wire wheels.
- Continuously move the tool in a forward and back motion to avoid creating gouges in the work surface. Allowing the tool to rest on the work surface without moving, or moving the tool in a circular motion causes burning and swirling marks on the work surface.
- Remove the tool from the work surface before turning the tool off. Allow the tool to stop rotating before setting it down.



CAUTION: Use extra care when working over an edge, as a sudden sharp movement of grinder may be experienced.

Using Cutting (Type 1) Wheels



WARNING: Do not use edge grinding/cutting wheels for surface grinding applications because these wheels are not designed for side pressures encountered with surface grinding. Wheel breakage and injury may result.

- Allow tool to reach full speed before touching tool to work surface.
- Apply minimum pressure to work surface, allowing tool to operate at high speed. Cutting rate is greatest when the tool operates at high speed.
- Once a cut is begun and a notch is established in the workpiece, do not change the angle of the cut. Changing the angle will cause the wheel to bend and may cause wheel breakage.
- Remove the tool from work surface before turning tool off. Allow the tool to stop rotating before setting it down.

Precautions To Take When Wire Brushing Paint

- Wire brushing of lead based paint is NOT RECOMMENDED due to the difficulty of controlling the contaminated dust. The greatest danger of lead poisoning is to children and pregnant women.
- Since it is difficult to identify whether or not a paint contains lead without a chemical analysis, we recommend the following precautions when wire brushing any paint:

PERSONAL SAFETY

- No children or pregnant women should enter the work area where the paint removal is being done until all clean up is completed.
- A dust mask or respirator should be worn by all persons entering the work area. The filter should be replaced daily or whenever the wearer has difficulty breathing.

NOTE: Only those dust masks suitable for working with lead paint dust and fumes should be used. Ordinary painting masks do not offer this protection. See your local hardware dealer for the proper respiratory protection.

- NO EATING, DRINKING or SMOKING should be done in the work area to prevent ingesting contaminated paint particles. Workers should wash and clean up BEFORE eating, drinking or smoking. Articles of food, drink, or smoking should not be left in the work area where dust would settle on them.

ENVIRONMENTAL SAFETY

- Paint should be removed in such a manner as to minimize the amount of dust generated.
- Areas where paint removal is occurring should be sealed with plastic sheeting of 4 mils thickness.

3. Wire brushing should be done in a manner to reduce tracking of paint dust outside the work area.

CLEANING AND DISPOSAL

1. All surfaces in the work area should be vacuumed and thoroughly cleaned daily for the duration of the wire brushing project. Vacuum filter bags should be changed frequently.
2. Plastic drop cloths should be gathered up and disposed of along with any dust chips or other removal debris. They should be placed in sealed refuse receptacles and disposed of through regular trash pick-up procedures.

During clean up, children and pregnant women should be kept away from the immediate work area.

3. All toys, washable furniture and utensils used by children should be washed thoroughly before being used again.

Metal Applications

When using the tool in metal applications, make sure that a residual current device (RCD) has been inserted to avoid residual risks caused by metal swarf.

If the power supply is shut off by the RCD, take the tool to an authorised DEWALT repair agent.



WARNING: In extreme working conditions, conductive dust can accumulate inside the machine housing when working with metal. This can result in the protective insulation in the machine becoming degraded with a potential risk of an electrical shock.

To avoid build-up of metal swarf inside the machine, we recommend to clear the ventilation slots on a daily basis. Refer to **Maintenance**.

MAINTENANCE

Your DEWALT power tool has been designed to operate over a long period of time with a minimum of maintenance. Continuous satisfactory operation depends upon proper tool care and regular cleaning.



WARNING: To reduce the risk of serious personal injury, turn tool off and disconnect tool from power source before making any adjustments or removing/installing attachments or accessories. Before reconnecting the tool, depress and release the trigger switch to ensure that the tool is off.

The charger and battery pack are not serviceable. There are no serviceable parts inside.

Pop-off Brushes

The motor will be automatically shut off indicating that the carbon brushes are nearly worn out and that the tool needs servicing. The carbon brushes are not user-serviceable. Take the tool to an authorised DEWALT repair agent.



Lubrication

Your power tool requires no additional lubrication.



Cleaning



WARNING: Blow dirt and dust out of the main housing with dry air as often as dirt is seen collecting in and around the air vents. Wear approved eye protection and approved dust mask when performing this procedure.



WARNING: Never use solvents or other harsh chemicals for cleaning the non-metallic parts of the tool. These chemicals may weaken the materials used in these parts. Use a cloth dampened only with water and mild soap. Never let any liquid get inside the tool; never immerse any part of the tool into a liquid.

CHARGER CLEANING INSTRUCTIONS



WARNING: Shock hazard. Disconnect the charger from the AC outlet before cleaning. Dirt and grease may be removed from the exterior of the charger using a cloth or soft non-metallic brush. Do not use water or any cleaning solutions.

Optional Accessories



WARNING: Since accessories, other than those offered by DEWALT, have not been tested with this product, use of such accessories with this tool could be hazardous. To reduce the risk of injury, only DEWALT recommended accessories should be used with this product.

Consult your dealer for further information on the appropriate accessories.

Protecting the Environment



Separate collection. This product must not be disposed of with normal household waste.

Should you find one day that your DEWALT product needs replacement, or if it is of no further use to you, do not dispose of it with household waste. Make this product available for separate collection.



Separate collection of used products and packaging allows materials to be recycled and used again. Re-use of recycled materials helps prevent environmental pollution and reduces the demand for raw materials.

Local regulations may provide for separate collection of electrical products from the household, at municipal waste sites or by the retailer when you purchase a new product.

DEWALT provides a facility for the collection and recycling of DEWALT products once they have reached the end of their working life. To take advantage of this service please return your product to any authorised repair agent who will collect them on our behalf.

You can check the location of your nearest authorised repair agent by contacting your local DEWALT office at the address indicated in this manual. Alternatively, a list of authorised DEWALT repair agents and full details of our after-sales service and contacts are available on the Internet at: **www.2helpU.com**.











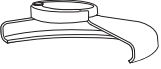

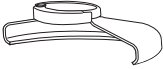



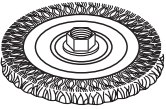
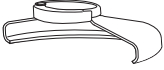

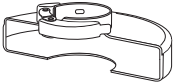

Rechargeable Battery Pack

This long life battery pack must be recharged when it fails to produce sufficient power on jobs which were easily done before. At the end of its technical life, discard it with due care for our environment:

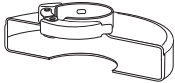
- Run the battery pack down completely, then remove it from the tool.
- Li-Ion cells are recyclable. Take them to your dealer or a local recycling station. The collected battery packs will be recycled or disposed of properly.

GRINDING AND CUTTING ACCESSORY CHART

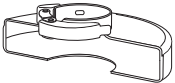
<i>Guard Type</i>	<i>Accessory</i>	<i>Description</i>	<i>How to Fit Grinder</i>
 TYPE 27 GUARD		Depressed centre grinding disc	 Type 27 guard  Backing flange
		Wire wheels	 Type 27 depressed centre wheel  Threaded clamp nut
		Wire wheels with threaded nut	 Type 27 guard  Wire wheel
		Wire cup with threaded nut	 Type 27 guard  Wire brush

 <p>TYPE 1 GUARD</p>		<p>Masonry cutting disc, bonded</p>	 <p>Type 1 guard</p>  <p>Backing flange</p>  <p>Cutting wheel</p>  <p>Threaded clamp nut</p>
 <p>TYPE 1 GUARD</p> <p>OR</p>  <p>TYPE 27 GUARD</p>		<p>Diamond cutting wheels</p>	

锂电池充电式角磨机

DCG412

恭喜！

感谢您选购得伟工具。凭借多年的产品开发和创新能力，得伟已经成为专业电动工具用户最可靠的合作伙伴之一。

技术参数

		DCG412
电压	V_{DC}	18
空载/额定转速	转/分	7000
砂轮直径	毫米	100
主轴直径		M10
重量（不含电池组）	千克	2.2*

电池组	DCB180	DCB181	DCB182
电池类型	锂离子	锂离子	锂离子
电压	V_{DC}	18	18
电容	A_h	3.0	1.5
重量	千克	0.64	0.35
		0.61	

充电器		DCB105		
电源电压	V_{AC}	220		
电池类型		锂离子		
大约充电时间	分钟	30	55	
		(1.5 Ah 电池组)	(3.0 Ah 电池组)	
			70	
			(4.0 Ah 电池组)	
重量	千克	0.49		

定义：安全指引

下列定义解释了各警示词的严重程度。请仔细阅读本手册，并注意这些警示符号。



危险：表示存在紧急危险情况，如果不加以避免，将导致**死亡或严重伤害**。



警告：表示存在潜在危险情况，如果不加以避免，可能导致**死亡或严重伤害**。



警示：表示存在潜在危险情况，如果不加以避免，可能导致**轻度或中度伤害**。

注意：表示存在**不涉及人身伤害的情况**，如果不加以避免，可能导致**财产损失**。



表示存在触电风险。



表示存在火灾风险。



警告：为降低伤害风险，请阅读使用手册。

电动工具通用安全警告



警告！阅读所有警告和所有说明。不遵照以下警告和说明会导致电击、着火和/或严重伤害。

保存所有警告和说明书以备查阅。

安全警告中提到的“电动工具”指电源供电类电动工具和电池充电类电动工具。

1) 工作场地的安全

- 保持工作场地**清洁和明亮**。混乱和黑暗的场地会引发事故。
- 不要在**易爆环境**，如有易燃液体、气体或粉尘的环境下操作电动工具。电动工具产生的火花会点燃粉尘或气体。
- 让**儿童和旁观者离开**后操作电动工具。注意力不集中会让你失去对工具的控制。

2) 电气安全

- 电动工具插头必须与插座**匹配**。绝不能以任何方式改装插头。需接地的电动工具**不能使用任何转换插头**。未经改装的插头和相配的插座将减少电击危险。
- 避免人体接触接地表面，如管道、散热片和冰箱。如果你身体接地会增加电击危险。
- 不得将电动工具**暴露在雨中或潮湿环境中**。水进入电动工具将增加电击危险。
- 不得**滥用电线**。绝不能用电线搬运、拉动电动工具或拔出其插头。使电线远离热源、

油、锐边或运动部件。受损或缠绕的软线会增加电击危险。

- e) 当在户外使用电动工具时，使用适合户外使用的外接软线。适合户外使用的软线将减少电击危险。
- f) 如果在潮湿环境下操作电动工具是不可避免的，应使用剩余电流动作保护器（RCD）。使用RCD可减小电击危险。

3) 人身安全

- a) 保持警觉，当操作电动工具时关注所从事的操作并保持清醒。当你感到疲倦，或在有药物、酒精或治疗反应时，不要操作电动工具。在操作电动工具时瞬间的疏忽会导致严重人身伤害。
- b) 使用个人防护装置。始终佩戴护目镜。安全装置，诸如适当条件下使用防尘面具、防滑安全鞋、安全帽、听力防护等装置能减少人身伤害。
- c) 防止意外起动。确保开关在连接电源和/或电池盒、拿起或搬运工具时处于关断位置。手指放在已接通电源的开关上或开关处于接通时插入插头可能会导致危险。
- d) 在电动工具接通之前，拿掉所有调节钥匙或扳手。遗留在电动工具旋转零件上的扳手或钥匙会导致人身伤害。
- e) 手不要伸展得太长。时刻注意立足点和身体平衡。这样在意外情况下能很好地控制电动工具。
- f) 着装适当。不要穿宽松衣服或佩戴饰品。让你的衣服、手套和头发远离运动部件。宽松衣服、佩饰或长发可能会卷入运动部件中。
- g) 如果提供了与排屑、集尘设备连接用的装置，要确保他们连接完好且使用得当。使用这些装置可减少尘屑引起的危险。

4) 电动工具使用和注意事项

- a) 不要滥用电动工具，根据用途使用适当的电动工具。选用适当设计的电动工具会使你工作更有效、更安全。

- b) 如果开关不能接通或关断工具电源，则不能使用该电动工具。不能用开关来控制的电动工具是危险的且必须进行修理。
- c) 在进行任何调节、更换附件或贮存电动工具之前，必须从电源上拔掉插头和/或使电池盒与工具脱开。这种防护性措施将减少工具意外起动的危险。
- d) 将闲置不用的电动工具贮存在儿童所及范围之外，并且不要让不熟悉电动工具或对这些说明不了解的人操作电动工具。电动工具在未经培训的用户手中是危险的。
- e) 保养电动工具。检查运动件是否调整到位或卡住，检查零件破损情况和影响电动工具运行的其他状况。如有损坏，电动工具应在使用前修理好。许多事故由维护不良的电动工具引发。
- f) 保持切削刀具锋利和清洁。保养良好的有锋利切削刃的刀具不易卡住而且容易控制。
- g) 按照使用说明书，考虑作业条件和进行的作业来使用电动工具、附件和工具的刀头等。将电动工具用于那些与其用途不符的操作可能会导致危险。

5) 电池式工具使用和注意事项

- a) 只用制造商规定的充电器充电。将适用于某种电池盒的充电器用到其他电池盒时会发生着火危险。
- b) 只有在配有专用电池盒的情况下才使用电动工具。使用其他电池盒会发生损坏和着火危险。
- c) 当电池盒不用时，将它远离其他金属物体，例如回形针、硬币、钥匙、钉子、螺丝或其他小金属物体，以防一端与另一端连接。电池端部短路会引起燃烧或火灾。
- d) 在滥用条件下，液体会从电池中溅出，避免接触。如果意外碰到了，用水冲洗。如果液体碰到了眼睛，还要寻求医疗帮助。从电池中溅出的液体会发生腐蚀或燃烧。

6) 维修

- a) 让专业维修人员使用相同的备件维修电动工具。这将保证所维修的电动工具的安全。

附加安全细则

所有操作的安全指示

- a) 该电动工具是用于实现角磨机、钢丝刷或切断工具功能的。阅读随该电动工具提供的所有安全警告、说明、图解和规定。不了解以下所列所有说明将导致电击、着火和/或严重伤害。
- b) 推荐用该电动工具进行诸如砂光和抛光等操作。电动工具不按指定的功能去操作，可能会发生危险和引起人身伤害。
- c) 禁止使用非专门为此工具设计或非经工具生产商推荐的附件。该附件即使能安装到工具上但也无法确保安全操作。
- d) 附件的额定转速必须至少等于电动工具上标出的最大转速。附件以比其额定转速大的转速运转会发生爆裂和飞溅。
- e) 附件的外径和厚度必须在电动工具的额定能力范围内。不正确的附件尺寸不能得到充分防护或控制。
- f) 砂轮、法兰、靠背垫或任何其他附件的轴孔尺寸必须适合安装到电动工具的主轴上。带轴孔的、与电动工具安装件不相配的附件将失稳、过度振动并会引起失控。
- g) 不要使用破损的附件。在每次使用前，请先检查附件，例如砂轮是否有碎屑和裂痕，靠背垫是否有裂缝、撕裂或过度磨损，钢丝刷是否松动或金属丝是否断裂。如果电动工具或附件跌落，请检查是否其是否受损，或者安装未受损的附件。检查并安装附件后，让自己和旁观者的位置远离旋转附件的平面，并以电动工具最大空载速度运行 1 min。损坏的附件通常在该试验时会碎裂。
- h) 佩戴个人防护装备。根据适用情况，使用面罩、安全护目镜或防护眼镜。适用时，戴上防尘面罩、听力保护器、手套和能挡小磨料或工件碎片的工作围裙。护目装备必须能够阻挡住各种操作产生的飞屑。防尘面具或口罩必须能够过滤操作产生的颗粒。长期暴露在高强度噪声中会引起失聪。
- i) 让旁观者与工作区域保持一安全距离。任何进入工作区域的人必须戴上防护用品。工件或破损附件的碎片可能会飞出并引起紧靠着操作区域的旁观者的伤害。切割附件触及带电导线会使电动工具外露的金属零件带电，并使操作者触电。
- j) 在切割附件有可能切割到暗线或自身电线的场所进行操作时，只能通过绝缘握持面来握住电动工具。切割附件碰到一根带电导线会使电动工具外露金属零件带电并使操作者发生电击危险。
- k) 使软线远离旋转的附件。如果控制不当，软线可能被切断或缠绕，并使得您的手或手臂可能被卷入旋转附件中。
- l) 直到附件完全停止运动才放下电动工具。旋转的附件可能会抓住表面并拉动电动工具而让您失去对工具的控制。
- m) 当携带电动工具时不要开动它。意外接触旋转附件可能会缠绕您的衣服而伤害身体。
- n) 经常清理电动工具的通风口。电动机风扇会将灰尘吸进机壳，过多的金属粉尘沉积可能会导致电气危险。
- o) 不要在易燃材料附近操作电动工具。火星可能会点燃这些材料。
- p) 不要使用需用冷却液的附件。用水或其他冷却液可能会导致电腐蚀或电击。

所有操作的进一步安全指示

反弹原因以及操作员对反弹现象的预防措施

反弹是因卡住或缠绕住的旋转砂轮、靠背垫、钢丝刷或其他附件而产生的突然反作用力。卡住或缠绕会引起转动附件的迅速堵转，随之使失控的电动工具在卡住点产生与附件旋转方向相反的运动。

例如，如果砂轮被工件缠绕或卡住，伸入卡住点的砂轮边缘可能会进入材料表面而引起砂轮爬出或反弹。砂轮可能会飞向或飞离操作员，这取决于砂轮在卡住点的运动方向。在这些条件下砂轮也可能会碎裂。

反弹是由于电动工具使用不当和/或不正确的操作程序或条件造成的。适当采取以下预防措施即可避免反弹现象：

- a) 保持紧握电动工具，使您的身体和手臂处于正确状态以抵抗反弹力。如有辅助手柄，则要一直使用，以便最大限度地控制住起动时的反弹力或反力矩。
- b) 双手切勿靠近转动附件。附件可能会反弹碰到手。
- c) 不要站在电动工具发生反弹后可能移动到的区域。反弹将在缠绕点驱使工具逆砂轮运动方向运动。
- d) 在尖角、锐边等处作业时要特别小心。应避免附件撞击和受阻。尖角、锐边或撞击可能会阻碍旋转附件并引起失控或反弹。
- e) 不要附上锯链、木雕锯片或带齿锯片。这些锯片会经常导致反弹和失控。

磨削和砂轮切割操作的专用安全警告

- a) 只使用所推荐的砂轮型号和为选用砂轮专门设计的护罩。非电动工具专用砂轮无法得到充分的保护，而且不够安全。

- b) 护罩必须牢固地装在电动工具上，且放置得最具安全性，只有最小的砂轮部分暴露在操作员面前。护罩有助于保护操作人员免受爆裂砂轮碎片和意外触及砂轮的危險以及可燃衣服的火花的伤害。
- c) 砂轮只用于推荐的用途。例如：不要使用切割砂轮的侧面进行磨削。切割砂轮设计用于圆周磨削，施加到砂轮侧面的力可能会使其碎裂。
- d) 始终为所选砂轮选用未损坏的、有恰当规格和形状的砂轮法兰盘。适当的砂轮法兰可支撑砂轮，从而降低砂轮破裂的可能性。切割砂轮法兰可能不同于磨削砂轮法兰。
- e) 不要使用从大规格电动工具上用剩的磨损砂轮。用于大规格电动工具的砂轮不适用于较小规格工具的高速工况，并且可能会发生爆裂。

切割操作的附加安全说明

对砂轮切割操作的独家专用安全警告

- a) 不要“夹”住切割砂轮或施加过大的压力。不要试图过深地切割。给砂轮施加过应力增加了砂轮在切割时地负载，容易缠绕或卡住，增加了反弹或砂轮爆炸的可能性。
- b) 身体不要对着旋转砂轮，也不要站在其后。当把砂轮从操作者身边的操作点移开时，可能的反弹可能会使旋转砂轮和电动工具朝你推来。
- c) 当砂轮被卡住或无论如何原因而中断切割时，关掉电动工具并握住工具不要动，直到砂轮完全停止。绝不要试图当砂轮仍然运转时使切割砂轮脱离切割，否则会发生反弹。调查并采取矫正措施以消除砂轮卡住的原因。
- d) 不能在工件上重新起动切割操作。让砂轮达到全速后再小心地重新进入切割。如果电动工具在工件上重新起动，砂轮可能会卡住、爬出或回弹。

- e) 支持住板材或超大工件可使得砂轮卡住和反弹的危险降到最低限度。大工件凭借自重而下垂。必须在工件靠近切割线处和砂轮两侧近工件边缘处放置支撑。
- f) 当进行“盲切割”进入墙体或其他盲区时要格外小心。伸出的砂轮可能会割到煤气管或水管，电线或由此引起反弹的物体。



请佩戴护目装备。

日期码位置 (图 1)

包含制造年份的日期码 (s) 印在工具外壳上。

例如：

2013 XX XX

制造年份

钢丝刷操作的专用安全警告

- a) 请注意，即使在正常操作期间，钢丝线也会随刷子甩出。不要对钢丝刷施加过量负载而使得钢丝线承受过应力。钢丝线可能会轻易刺入薄衣物和/或皮肤内。
- b) 如果建议钢丝刷使用护罩，则不允许该护罩对钢丝轮或钢丝刷有任何干扰。钢丝轮或钢丝刷在工作负荷和离心力的作用下，直径会变大。

附加安全信息

- 附件的螺纹安装必须与角磨机主轴螺纹相配。对于通过法兰安装的附件，附件的轴孔必须适合法兰的定位直径。与电动工具安装件不相配的附件将失衡、过度震动并会引起失控。
- 中心凹陷的砂轮的磨削表面必须安装在护罩边缘平面的下方。安装不当且穿过护罩边缘平面的砂轮得不到充分保护。

剩余风险

尽管遵守了相关的安全法规并采用了安全装备，某些剩余风险仍然是无法避免的。这些风险包括：

- 听力损伤。
- 飞散颗粒造成的人身伤害风险。
- 操作过程中附件加热而产生的烧伤危险。
- 长时间使用引起的人身伤害。
- 危害物质粉尘引起的风险。

工具上的标记

工具上印有下列标志：



使用前请阅读使用手册。

针对所有电池充电器的重要安全说明

请妥善保管好这些说明： 本手册包含重要的 DCB105 电池充电器安全和操作说明。

- 使用充电器之前，请阅读所有说明和充电器、电池组以及电池组产品上的警示标记。



警告： 触电危险。禁止任何液体渗入充电器，否则会引起触电。



注意： 灼伤危险。为降低受伤风险，只使用得伟充电式电池组充电。其他类型的电池可能会过热爆裂，造成人身伤害和财产损失。



警示： 应看管好儿童，以确保他们不将此设备当做玩具来玩。

注意： 在某些情况下，充电器连接电源时，异物可能会连接充电器内的外露充电触点而造成短路。请勿让能导电的异物靠近充电器腔，这些异物包括但不限于钢棉、铝箔或任何金属颗粒的堆积物。充电器内没有电池组时，请断开充电器与电源的连接。清洗前，务必拔掉充电器。

- 请勿使用本手册指定的充电器以外的其他任何充电器为电池组充电。充电器和电池组都是专门设计的，互相配合使用。
- 除了为得伟充电式电池充电以外，这些充电器都不能用于其他任何用途。否则，可能会导致火灾、触电或电击。
- 请勿将充电器暴露于雨或雪中。

- **断开充电器时应拔下插头，切勿拉拽电线。**这将减少电源插头和电源线损坏的风险。
- **确保电源线布置在不易踩踏、踢绊、拉扯或会受到损坏或压力的位置。**
- **非绝对必要条件下禁止使用延长线。**使用延长线不当可能会导致火灾、触电或电击的危险。
- **户外操作充电器时，要保持干燥，使用适合户外使用的延长电线。**适合户外使用的电线将减少触电的危险。
- **禁止堵塞充电器上的通风槽。**通风槽位于充电器的顶部和两侧。将充电器放置在远离任何热源的位置。
- **禁止使用电源线或插头已损坏的充电器** — 请立即更换已损坏的充电器。
- **禁止使用受过重击、掉落或以其他方式受损的充电器。**请将损坏的充电器送到授权维修中心维修。
- **禁止拆卸充电器，请将需要维修或修理的充电器送到授权维修中心。**重装不正确可能会引起触电、电击或火灾的危险。
- **已损坏的电源线必须立即交由制造商、服务代理或类似的合格人员进行更换以防止安全隐患。**
- **清洁前，请断开充电器和插座的连接，以降低触电风险。**取出电池组不会降低触电风险。
- **切勿将两个充电器连接在一起。**
- **充电器额定电压是标准 220 V 家用电压。禁止在任何其他电压下使用充电器。**此规则不适用于车载充电器。

请妥善保管好这些说明

充电器

DCB105 充电器适用于：10.8 V、14.4 V 和 18 V 的锂离子（DCB121、DCB123、DCB140、

DCB141、DCB142、DCB180、DCB181 和 DCB182）电池组。

该充电器无需调整，专为简易操作而设计。





充电程序（图 2）

1. 插入电池组前请将充电器插入到合适的 220 V 插座。
2. 将电池组 (j) 插入到充电器中，确保电池组完全就位。红色（充电中）指示灯将不断闪烁，表示充电过程已经开始。
3. 红色灯持续亮起表示充电完成。此时电池组已完全充电，您可以使用电池组或将电池组留在充电器上。

注：为了确保锂离子电池的效能和使用寿命最大化，在首次使用电池组之前必须将其完全充电。

充电过程

关于电池组的充电状态，请参阅下表。

充电状态	
 充电中	— — — —
 已完全充电	—————
 热/冷电池组延迟	—●—●—●—●—●
 故障电池组或充电器	●●●●●●●●●●
 故障电源线	●●●●●●●●●●

此充电器不能为故障电池组充电。充电器指示灯不亮或“故障电池组或充电器”指示灯闪烁时，表示电池有故障。

注：这也可能意味充电器有故障。

如果充电器提示存在故障，请将充电器和电池组送到授权的维修中心进行测试。

热/冷电池组延迟

当充电器检测到电池过热或过冷时，它会启动热/冷电池延迟模式，暂停充电，直到电池达到适当的温度。然后，充电器会自动切换到电池组充电模式。此功能可确保电池拥有最长的使用寿命。

XR 锂离子电池工具具有“电子保护系统”设计，可保护电池免受过载、过热或过度放电之害。

如果电子保护系统处于运作状态，该工具将自动停止操作。如果发生这种情况，请将锂离子电池放在充电器上直到完全充电。

冷电池组充电速度约为热电池组充电速度的一半。电池组在整个充电周期的充电速度都会较慢，即使电池升温也不会恢复到最大速度。

针对所有电池组的重要安全说明

在订购更换电池组时，请务必附上目录号码和电压。

包装箱内的电池组并未完全充电。在使用电池组和充电器之前，请阅读下面的安全说明，然后按照所述充电程序进行操作。

请阅读所有说明

- 禁止在易爆环境中充电或使用电池组，如有易燃液体、气体或粉尘的环境。在充电器中插入或取出电池组时可能会点燃粉尘或烟雾。
- 切勿将电池组强行插入充电器。禁止以任何方式改装电池组并将电池组插入不兼容的充电器，这种操作可能会导致电池组破裂，造成严重的人身伤害。
- 只使用指定的得伟充电器为电池组充电。
- 请勿喷溅电池组或将其浸泡在水或其他液体中。
- 禁止在温度可能达到或超过 40 °C (105 °F) 的地方（如夏天户外的棚子或金属建筑物中）存储或使用工具和电池组。
- 为达到最佳效果，请确保电池组在使用前完全充电。



警告：请勿以任何理由试图打开电池组。电池组外壳破裂或损坏时，不要将电池组插入充电器。不要挤压、掉落或损坏电池组。不要使用受过强烈重击、掉落、碾压或以任何其它方式（如被钉子穿破、受到锤子的重击、踩踏）受损的电池组或充电器，否则可能会引起触电或电击。损坏的电池组应交回服务中心进行回收。



注意：不用时，将工具侧放在平稳的表面上，确保不会有踢绊或掉落的危险。

一些具有大型电池组的工具将直立于电池组之上，但可能会轻易被撞倒。

锂离子电池的安全说明

- 即使电池组已经严重受损或已完全耗竭也不可焚烧处理电池组。电池组会在火中会发生爆炸。锂离子电池在燃烧时会释放有毒气体和物质。
- 如果皮肤接触到电池内含物质，请立即用温和肥皂和水冲洗接触的地方。如果电池液进入眼睛，应睁开眼睛用清水冲洗至少 15 分钟或直到刺激感消失。如果需要医疗救助，请告知医护人员。电池电解质是由液状有机碳酸盐和锂盐的混合物组成。
- 已打开电池的內部物质可能会导致呼吸道刺激。请转移至新鲜空气处。如果症状持续存在，请就医。



警告：灼伤危险。电池液如果接触到火花或火焰就有可能燃烧。

电池组

电池类型

DCG412 使用 18 伏特电池组。

可以使用 DCB180、DCB181 或 DCB182 电池组。更多信息，请参阅 [技术参数](#)。

存放建议

1. 最好将电池存放在阴凉、干燥、远离阳光直射、不会过热或过冷的地方。为了获得最佳的电池性能和使用寿命，请您在不使用电池组时将其存放在室温下。
2. 长期存放时，建议将完全充电的电池组从充电器取出，存放在阴凉、干燥的地方，以达到最佳效果。

注：不能在电池电荷已完全耗尽的状态下存储电池组。使用电池组之前，必须重新为电池组充电。

充电器和电池组上的标签

除了在本手册中所使用的标志，充电器和电池组的标签还包括：



使用前请阅读使用手册。



充电中。



已完全充电。



热/冷电池组延迟。



故障电池组或充电器。



故障电源线。



请勿使用导电物体碰触。



禁止对损坏的电池组充电。



只使用得伟电池组。其他电池组可能会爆炸，导致人身伤害和损坏。



禁止暴露于水中。



电线故障，请立即更换。



只在 4°C 和 40°C 之间的温度下充电。



弃置电池组时，请妥善处理以保护我们的环境。



禁止焚烧电池组。



Li Ion 锂离子电池组充电。



有关充电时间，请参阅**技术参数**。



只能在室内使用。

包装内的物品

本产品包装内含有：

1 个角磨机

1 个 125 毫米护罩 (27 型号)

1 个侧手柄

1 个法兰套件

1 个双销扳手

1 个充电器

2 个锂离子电池组 (M2、L2 型号)

1 本使用手册

注：N 型号不包括电池组、充电器和维修箱。

- 检查工具、部件或附件是否在运输过程中损坏。
- 操作前，请抽空仔细阅读并掌握本手册。

说明 (图 1-3)



警告：切勿改装电动工具或其任何部件，否则可能会导致损坏或人身伤害。

- 触发开关
- 锁止按钮
- 主轴锁按钮
- 主轴
- 侧手柄
- 砂轮
- 靠背法兰
- 螺纹紧固螺母
- 护罩
- 电池组
- 护罩制动装置
- 接口
- 齿轮箱槽
- 调节螺钉
- 电池释放按钮

p. 电量计按钮

设计用途

DCG412 重型角磨机设计用于专业磨削和切割。

禁止使用中心凹陷砂轮以外的砂轮。

禁止在潮湿环境中或在有易燃液体或气体的环境中使用本工具。

这些重型角磨机是专业型电动工具。

请勿让儿童接触本工具。缺乏经验的操作员需要在监督下使用本工具。

- 本产品不适合体力、感官或智力不足以及缺乏经验、知识或技能的人员（包括儿童）使用，除非一旁有能为他们的安全负责的监督人员。不得在无人监管的情况下让儿童触及本产品。

电器安全

电机只适用一种工作电压。请务必检查电池组的电压是否和铭牌上的电压一致。另外，请确保充电器电压和主电源的电压一致。



您的得伟充电器符合 EN60335 双重绝缘要求，因此无需使用接地线。

电源线损坏时，必须由得伟服务部门采用专门制备的电线进行更换。

使用延长电缆

除非绝对必要，否则请勿使用延长线。使用适合您的充电器电源输入的合格延长线（见**技术参数**）。导线的最小尺寸为 1mm²；最大长度为 30 m。

使用电缆卷筒时，请务必拉出所有的电缆。

组装和调整



警告：为降低严重的人身伤害风险，在进行任何调整或取出/安装配件或附件之前，请关闭工具电源和断开工具电源连接。重新连接工具之前，请按下并松开触发开关以确保工具已关闭。****



警告：只使用得伟电池组和充电器。

插入和拆除电池组（图 2）

注：为达到最佳效果，请确保电池组在使用前完全充电。

将电池组安装到工具手柄中

1. 将电池组 (j) 对齐工具手柄内的轨道（图 2）。
2. 将电池组滑入手柄内，使其牢牢地固定在工具内，并确保不会脱离。

从工具中取出电池组

1. 按电池释放按钮 (o)，并用力将电池组从工具手柄中拉出。
2. 按本手册充电器部分所述将电池组插入充电器中。

电池组电量计（图 2）

一些得伟电池组带有一个包含三个绿色 LED 指示灯的电量计，用于指示电池组内的剩余电量。

按下电量计按钮 (p) 不要松开，即可启动电量计。三个绿色 LED 指示灯将以组合方式亮起，以指示剩余电量。当电池内的电量低于可用限制时，电量计将不会亮起，电池则必须重新充电。

注：电量计仅指示电池组的剩余电量。它并不表示该工具的功能性能，且将根据产品组件、温度和最终用户的使用情况而用所不同。

安装侧手柄（图 1）



警告：使用工具之前，请检查手柄是否牢固拧紧。



警告：应始终使用侧手柄，以时刻保持对工具的控制。

将侧手柄 (e) 牢固地旋入齿轮箱任一侧的其中一个孔中。

为了提高使用舒适度，切割操作时要将齿轮箱旋转 90°。

旋转齿轮箱（图 1）

1. 拆下四个用于安装齿轮箱到马达外壳的角螺钉。

2. 不用将齿轮箱与马达外壳分开，将齿轮箱头旋转到所需位置。

注：如果齿轮箱和马达外壳分开超过 1/8 英寸（3.17 毫米），则必须将本工具交由得伟维修中心维修和重新组装。否则，将造成钢丝刷、马达和轴承发生故障。

3. 重新安装螺钉，以将齿轮箱安装到马达外壳。以 20 英寸磅扭矩旋紧螺钉。旋得过紧会造成螺钉滑牙。

安装和取出护罩（图 3）



警告：为降低严重的人身伤害风险，在进行任何调整或取出/安装配件或附件之前，请关闭工具电源和断开工具电源连接。重新连接工具之前，请按下并松开触发开关以确保工具已关闭。



警告：护罩必须与本角磨机一同使用。

将 DCG412 角磨机用于切割金属或砖石时，必须使用 1 型号护罩。1 型号护罩可从得伟经销商处另行购买。

注：请参阅本节结束处的磨削和切割附件图表，查看可与本角磨机配合使用的其他附件。

1. 将工具放置在工作台上，主轴 (d) 朝上。
2. 打开护罩锁门 (k)，并将护罩上的接片 (l) 与齿轮箱上的槽 (m) 对齐。
3. 向下推护罩直到护罩接片啮合，并在齿轮箱轮毂上的槽中自由转动。
4. 在护罩锁门打开的情况下，将护罩 (i) 旋转到所需的工作位置。
5. 关闭护罩锁门以固定护罩在齿轮箱上。



警告：如果调整螺钉 (n) 仍无法锁紧护罩，请不要使用该工具。为降低人身伤害危险，请将该工具和护罩送交维修中心以维修或替换护罩。

注意：请勿在打开位置使用夹拨杆旋紧调节螺钉 (n)。可能对护罩或安装轮毂造成不易发现的损坏。

注：边缘磨削和切割可采用专为此用途设计的 27 型号砂轮进行；6.35 毫米（1/4 英寸）厚的砂轮用于表面磨削，而 3.17 毫米（1/8 英寸）厚的砂轮用于边缘磨削。

安装中心凹陷的砂轮

注：必须使用角磨机随附的 27 型号护罩。

安装和拆下带轮毂的砂轮（图 1、4）

带轮毂的砂轮直接安装到 M10 螺纹主轴上。

1. 用手将钢丝轮装到主轴 (d) 上。
2. 按下主轴锁按钮 (c) 并使用扳手拧紧钢丝轮轮毂。
3. 按上述相反的步骤拆除钢丝轮。

注意：如果开启工具前未能正确放置砂轮，可能会对工具或砂轮造成损坏。

安装带轮毂的砂轮（图 1、4）

注：必须使用角磨机随附的 27 型号护罩。

注：请参阅本节结束处的磨削和切割附件图表，查看可与本角磨机配合使用的其他附件。

1. 将工具放置在工作台上，护罩朝上。
2. 让凸起的中心靠近砂轮，将非螺纹靠背法兰 (g) 安装到主轴 (d) 上。
3. 将砂轮 (f) 紧靠靠背法兰，让砂轮在靠背法兰凸起中心置中。
4. 在按下主轴锁按钮 (c) 时，将紧固螺母 (h) 拧上主轴。如果您安装的砂轮厚度超过 1/8 英寸（3.17 毫米），则将螺纹紧固螺母放到主轴上，使凸起中心装入砂轮中心。如果您安装的砂轮厚度不超过 1/8 英寸（3.17 毫米），则将螺纹紧固螺母放到主轴上，使凸起中心不会靠在砂轮上。
5. 在按下主轴锁按钮 (c) 时，使用扳手拧紧紧固螺母。

6. 要拆下砂轮，按下主轴锁按钮并使用扳手拧松螺纹紧固螺母。

注：如果在拧紧紧固螺母后砂轮旋转，检查螺纹紧固螺母的朝向。如果安装的砂轮比较薄并且紧固螺母凸起中心紧靠砂轮，则砂轮将会旋转，因为凸起中心的高度可防止紧固螺母固定砂轮。

安装钢丝刷和钢丝轮（图 1）

将钢丝杯刷或钢丝轮直接安装在螺纹主轴上，而无需使用法兰。仅使用 M10 螺纹轮毂随附的钢丝刷或钢丝轮。这些附件可从当地经销商处或授权维修中心另行购买。

注：使用钢丝刷或钢丝轮时需要 27 型号护罩。



警告：为了降低人身伤害风险，请在处理钢丝刷或钢丝轮时戴上工作手套。钢丝刷或钢丝轮可能会变得非常锋利。



警告：为了降低工具损坏的风险，在安装或使用钢丝轮或钢丝刷不得接触到护罩。附件可能会出现不易发现的损坏，导致钢丝从钢丝轮或钢丝杯附件上脱落。

安装钢丝杯刷和钢丝轮

1. 将工具放置在工作台上，护罩朝上。
2. 用手将钢丝轮装到主轴上。
3. 按下主轴锁按钮 (c) 并在钢丝轮或钢丝刷轮毂上使用扳手拧紧钢丝轮。
4. 若要拆除钢丝轮，请按上述相反的步骤操作。

注意：为了降低损坏工具的风险，正确放置轮毂然后开启工具。

使用前的准备工作

- 安装护罩及合适的圆盘或砂轮。禁止使用过度磨损的圆盘或砂轮。
- 确保内部和外部法兰已正确安装。
- 确保圆盘或砂轮按附件和工具上的箭头方向转动。

操作

使用说明



警告：请务必遵守安全指示和适用法规。



警告：为降低严重的人身伤害风险，在进行任何调整或取出/安装配件或附件之前，请关闭工具电源和断开工具电源连接。重新连接工具之前，请按下并松开触发开关以确保工具已关闭。



警告：

- 确保所有要磨削或切割的材料已固定到位。
- 使用夹具或老虎钳夹紧工件，并将其支撑在稳定的平台上。务必牢固地夹住和撑住工件以防止工件移动和失控。工件移动或失控可能会引发危险并导致人身伤害。
- 轻轻地对工具施加压力。切勿对圆盘施加侧压力。
- 操作此工具时始终佩戴普通工作手套。
- 齿轮箱在使用期间温度变得很高。
- 始终安装护罩及合适的圆盘或砂轮。禁止使用过度磨损的圆盘或砂轮。
- 确保内部和外部法兰已正确安装。
- 确保圆盘或砂轮按附件和工具上的箭头方向转动。
- 避免过载。如果工具变得灼热，请让它在空载情况下运转几分钟。

正确的手持方式（图 1、6）



警告：为降低严重的人身伤害风险，请始终使用正确的手持方式，如图所示。



警告：为降低严重的人身伤害风险，预期有突然反应时**务必**紧握住工具。

正确的手持方式要求一只手握住侧手柄 (e)，另一只手握住工具主体，如图 6 所示。

开关



警告：使用工具之前，请检查手柄是否牢固拧紧。

锁止按钮和触发开关 (图 7)

您的切断工具配有锁止按钮 (b)。

若要锁定触发开关 (a)，按压图 7 所示的锁止按钮。将锁止按钮按压到锁定图标时，装置将被锁定。

搬运或储存工具时务必锁定触发开关，避免意外启动。

若要解锁触发开关，按下锁止按钮 (b)。将锁止按钮被按压到锁定图标时，装置将被锁定。锁止按钮变为红色，表示开关处于已解锁位置。

拉触发开关 (a) 以开启马达。松开触发开关会关闭马达。

注：此工具不提供将开关锁定在 ON (开启) 位置的功能，切勿通过任何其他方式来锁定在 ON (开启) 位置。



警告：紧握工具侧手柄和主体以在启动时和使用过程中保持对工具的控制，直到砂轮或附件停止转动。确保砂轮完全停止后才放下工具。



警告：让工具达到全速，然后再将工具放到工作表面。从工作表面提起工具，然后再关闭工具。

主轴锁 (图 1)

主轴锁 (c) 可在安装或拆除砂轮时防止主轴转动。只能在工具关闭、拔出电源插头且完全停止时使用主轴锁。

注意：为了降低工具损坏的风险，请勿在工具运行时使用主轴锁。否则将损坏工具，附着的附件可能会甩脱，从而导致伤害。

若要使用主轴锁，请按下主轴锁按钮 (c) 并转动主轴，直到无法再转动为止。

使用砂轮进行边缘磨削



警告：当本工具在执行切割工作或深磨削时，若用于切割和边缘磨削的砂轮出现弯曲或扭曲，则可能导致碎裂或回弹。为了降低严重伤害的风险，将采用标准 27 型号护罩的砂轮使用范围限制在浅切割和开槽 (深度小于 13 毫米 [1/2 英寸])。护罩的开口侧不得对着操作人员。对于使用 1 型号切割砂轮的较深切割，请使用封闭的 1 型号护罩。请参阅本节结束处的**磨削和切割附件图表**，查看可与本角磨机配合使用的其他附件。

1. 让工具达到全速，然后再将工具放到工作表面。
2. 在工作表面上施加最小的压力，让工具在高速下运行。磨削速度在工具于高速运行时最大。
3. 不要站在砂轮底面开口侧。
4. 一旦切割开始并在工件上形成了凹口，请勿改变切割角度。改变角度会造成砂轮弯曲，并可能导致砂轮破损。边缘磨削砂轮的设计不能耐受弯曲造成的侧压。
5. 从工作表面移开工具，然后再关闭工具。让工具停止转动后再将其放下。



警告：不要将边缘磨削/切割砂轮用于表面磨削，因为这些砂轮自身的设计构造并不足以抵抗表面磨削所产生的侧压。这样可能会导致砂轮爆裂或严重人员伤亡。

安装和使用钢丝刷和钢丝轮

钢丝刷和钢丝轮可用于除锈、氧化皮和油漆，并抚平不规则表面。

注：请参阅**钢丝刷除油漆需采取的预防措施**。

1. 让工具达到全速，然后再将工具放到工作表面。

2. 在工作表面上施加最小的压力，让工具在高速下运行。材料去除速度在工具于高速运行时最大。
3. 为钢丝轮刷在工具和工作表面之间保持 5° 至 10° 夹角。
4. 让砂轮边缘与钢丝轮工作表面之间保持接触。
5. 前后持续移动工具，以避免在工作表面上产生沟槽。让工具停在工作表面上不移动，或让工具转圈，使得在工作表面上留下灼热和旋动标记。
6. 从工作表面移开工具，然后再关闭工具。让工具停止转动后再将其放下。



警告：在边缘操作时要特别注意，因为角磨机可能突然发生大幅运动。

使用切割（1 型号）砂轮



警告：不要将边缘磨削/切割砂轮用于表面磨削，因为这些砂轮自身的设计构造并不足以抵抗表面磨削所产生的侧压。这样可能会导致砂轮爆裂或人员受伤。

1. 让工具达到全速，然后再将工具放到工作表面。
2. 在工作表面上施加最小的压力，让工具在高速下运行。切割速度在工具于高速下运行时最大。
3. 一旦切割开始并在工件上形成了凹口，请勿改变切割角度。改变角度会造成砂轮弯曲，并可能导致砂轮破损。
4. 从工作表面移开工具，然后再关闭工具。让工具停止转动后再将其放下。

钢丝刷除油漆需采取的预防措施

1. 由于难以控制污染灰尘，因此不建议对含铅的油漆进行钢丝刷操作。铅中毒的最大危害对象是儿童和孕妇。
2. 由于不经过化学分析而难以识别油漆是否含铅，因此我们建议在对任何油漆进行钢丝刷操作时采取下列预防措施：

人身安全

1. 在所有清理工作结束前，禁止儿童或孕妇进入在去除油漆的工作场所。
2. 进入此工作区域的所有人都应佩戴防尘面具或口罩。应每天或在佩戴者感到呼吸困难时更换滤网。
注：应该仅使用适合处理含铅油漆灰尘和烟雾的防尘面具。普通油漆面具不能提供这种保护。请咨询当地的硬件经销商，以了解正确的呼吸防护。
3. 不得在工作区域进食、饮水或吸烟，以防止摄取污染的油漆颗粒。工人应该在进食、饮水或吸烟前洗手和清理。食物、饮料或烟草不应留在会积聚灰尘的工作区域。

环境安全

1. 应该以尽可能减少积尘量的方式去除油漆。
2. 在执行去除油漆工作的区域应该使用 4 毫米厚的塑料板密封。
3. 在进行钢丝刷操作时，应该减少工作区域外的油漆灰尘痕迹。

清洁和处理

1. 在钢丝刷项目期间，应每天对工作区域的所有表面进行真空除尘和彻底清理。应经常更换真空滤袋。
2. 应该将滴塑布与任何木屑或其他移除碎片一起收集和处理。应该将它们放在密封的垃圾桶并通过定期垃圾收集程序进行处理。
清理期间，儿童和孕妇应该远离邻近的工作区域。
3. 儿童使用的所有玩具、可清洗家具和器具应在再次使用前彻底清洗。

金属应用

将工具用于金属时，确保已插入漏电保护器 (RCD) 以避免金属屑导致的剩余风险。

如果 RCD 切断电源，请将工具送交得伟授权维修代理。



警告：在极端工作条件下，处理金属时，机壳内部可能会积聚导电粉尘。这可能导致机器中的保护绝缘变弱，可能有触电的风险。

若要避免在机器内部积聚金属屑，我们建议每天清洁通风槽。请参阅 **维护**。

维护

得伟电动工具设计精良，可以长期使用，而且只需最少的维护。要连续获得令人满意的工作效果，需要进行合适的工具维护和定期清洁。



警告：为降低严重的人身伤害风险，在进行任何调整或取出/安装配件或附件之前，请关闭工具电源和断开工具电源连接。重新连接工具之前，请按下并松开触发开关以确保工具已关闭。

充电器和电池组无法维修。这些组件内没有可以维修的部件。

自停式碳刷

电机将自动关闭，指示碳刷快磨完，工具需要维修。碳刷不可由用户自行维修。请将工具送交得伟授权维修代理。



润滑

本电动工具无需另行润滑。



清洁



警告：一旦通风口和周围积聚了可见的粉尘，请立即用干燥的空气吹走主机外壳内的粉尘和灰尘。执行此过程

时，需戴上经认可的护目装备和防尘面具。



警告：切勿使用溶剂或其他烈性化学制品来清洁工具的非金属部件。这些化学物质可能会削弱这些部位使用的材料。请用布蘸温和的肥皂水擦拭。切勿让任何液体渗入工具，切勿让工具的任何部分浸在液体中。

充电器清洁说明



警告：触电危险。清洁前，请将充电器从交流电源插座上拔下。可用布或非金属软刷清除充电器外部的污垢和油脂。禁止使用水或任何清洁剂。

可选附件



警告：除了得伟提供的附件之外，其他附件都未经此产品兼容性测试，若将此类附件与本工具一起使用将存在安全隐患。为降低伤害风险，本产品只可使用得伟推荐的附件。

请向您的经销商咨询更多关于合适附件的信息。

保护环境



分类回收。本产品不得与普通家庭垃圾一起处理。



如果您发现您的得伟产品需要更换或您已经不再需要使用这些产品，请不要将它们与家庭垃圾一起处理。请将它们单独分类回收。



分类回收使用过的产品和包装能够让材料得以再循环和再利用。再生材料的再利用有助于防止环境污染，并降低对原材料的需求。

当地法规可能要求由市政废物处理点或向您出售新产品的零售商提供从家庭中分类回收电气产品的服务。

得伟提供设施收集和回收使用寿命到期的得伟产品。若要享受这项服务，请将产品送回任一授权维修代理，他们将代表我们回收您的产品。

请根据本手册所提供的地址与当地得伟办事处联系，查询离您最近的授权维修代理的位置。或者，您也可以登陆以下网站查询得伟授权维修代理名单，以及我们的售后服务和联系方式的详细信息，网址是：www.2helpU.com。



充电式电池组

本电池组使用寿命长，不能提供顺利完成工作所需的电力时，必须进行充电。电池技术寿命结束时，请妥善处理以保护我们的环境。

- 耗尽电池组的电力，然后从工具上拆下。
- 锂离子电池是可回收的。将它们送往您的经销商处或当地的回收站。回收的电池组将被妥善循环使用或处理。

制造商：百得德国公司

地 址：Black & Decker Str. 40 65510 Idstein,
德国

产 地：墨西哥

